

ALL-LITE

ACA-445

Aluminum Canopy
4" Airfoil Blade

The ACA-445 extruded aluminum canopy is designed to provide distinctive style to a building's exterior while keeping the building cool and saving energy by reducing glare and thermal load.

Standard Construction

Material: Mill finish aluminum

Frame Member: 8" tall x 2" deep (203 x 51) channel

Blades: 45° x 0.085" (2.2) thick airfoil style

Tieback Shroud: 1.3" tall x 1.08" wide x 0.085" thick
(33 x 27 x 2) pipe

Mounting Rail: Hidden

Minimum Size: 36" wide x 18" projection (914 x 457)

Maximum Size: Single section: 120" x 48" (3048 x 1219)

Multiple section: Unlimited width x 48" (1219)

Maximum shroud spacing is 96" (2438). Overhang is 12" (305) past shroud on each end.

Options

■ **Factory finish:**

- High Performance Fluoropolymer
- Baked Enamel
- Prime Coat

■ **Installation Hardware**

- Anchors for various building conditions

Ratings

Design Load: 50 psf downward / 30 psf upward

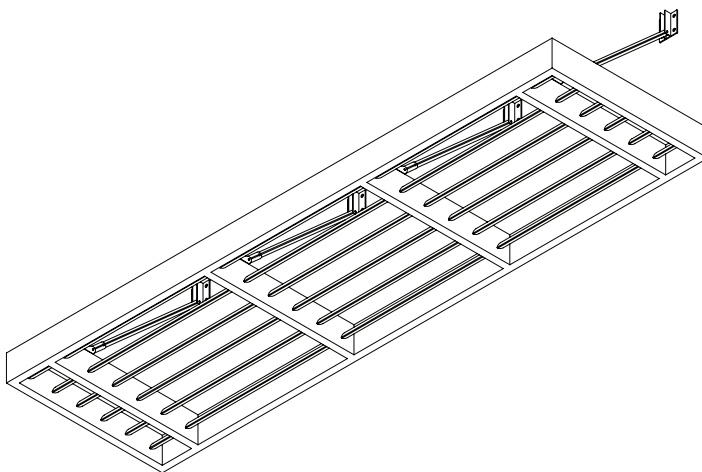
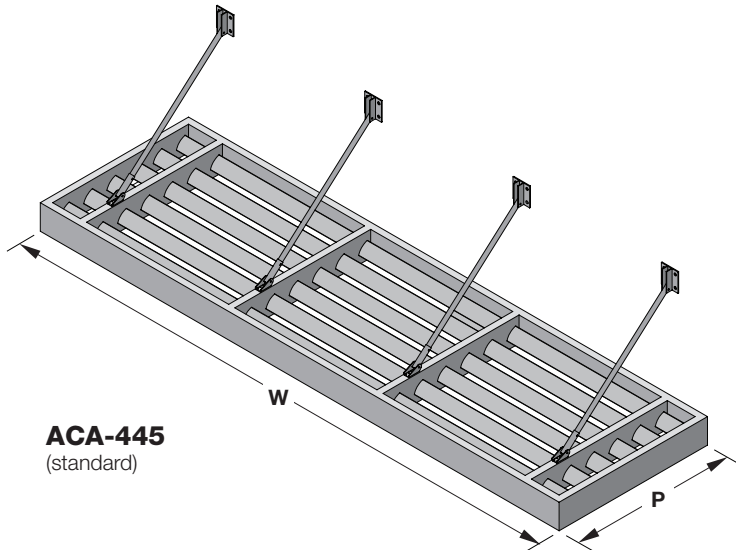

Underside View

5 year warranty

NOTE: Dimensions in parentheses () are millimeters.
Information is subject to change without notice or obligation.

Attributes

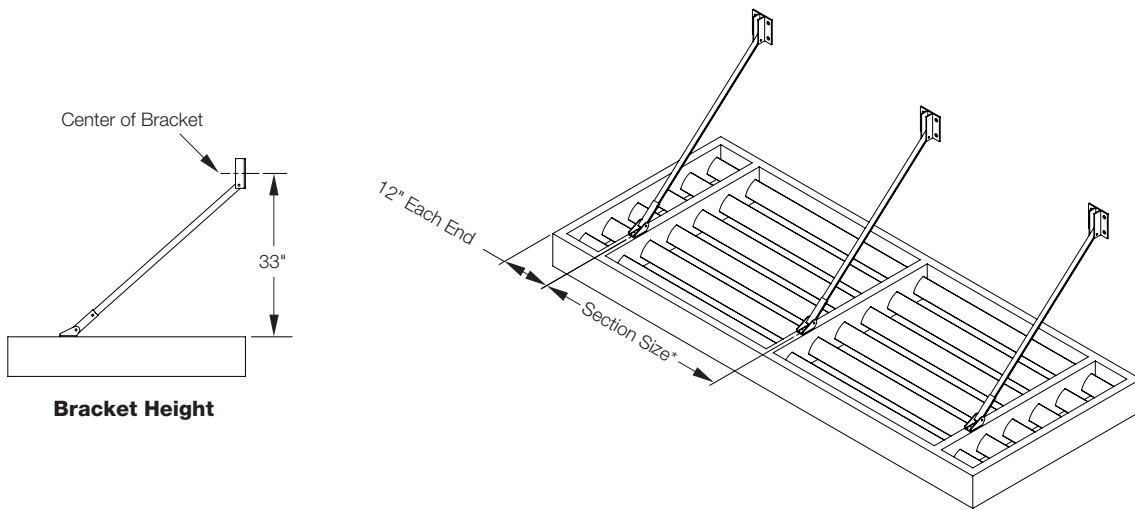

Section Sizing Detail

*Section size for single sections span entire width of canopy.