

## Application

The ECD-545 offers exceptional protection against wind-driven rain under the most severe conditions and is ideally suited for high wind areas or applications that are sensitive to wind-driven rain penetration. The ECD-545 incorporates horizontal blades and is available in a wide array of anodized and painted finishes including custom color matching.

## Standard Construction

- Material:** Mill finish 6063-T5 extruded aluminum.
- Frame:** 5" deep × 0.081" thick (127 × 2) channel.
- Blades:** 45° × 0.063" (1.6) thick horizontal drainable style.
- Screen:** 1/2" × 0.063" (12.7 × 1.6) expanded and flattened aluminum.
- Mullion:** Visible.
- Minimum Size:** 4.5" × 5" (114 × 127)
- Maximum Size:** Single section: 60" × 120" (1524 × 3048)  
120" × 60" (3048 × 1524)  
Multiple section: Unlimited

## Options

- Factory finish:
  - High Performance Fluoropolymer - 100% resin Newlar®/ 70% resin Kynar®
  - Baked Enamel
  - Clear or Color Anodized, Class 1
  - Prime Coat
- Hidden vertical mullion for continuous blade appearance.
- Flange frame:
  - 1 1/2" (38) flange
  - Custom-size flange
  - Stucco flange
  - Glazing frame
- Welded construction.
- Alternate bird or insect screens.
- Insulated or non-insulated blank-off panels.
- Filter racks.
- Hinged frame.
- Head and/or sill flashing.
- Installation hardware:
  - Clip angles
  - Continuous angles
- Burglar bars:
  - Shipped loose
  - Shipped mounted
- Frame closure.
- Florida Building Code Construction.  
(Refer to FBC Installation Instructions for additional requirements)

## Ratings

**Free Area:** [48" × 48" (1219 × 1219) unit]: 7.4 ft<sup>2</sup> (0.69 m<sup>2</sup>)  
46.3%

### Performance @ Beginning Point of Water Penetration

**Free Area Velocity:** Above 1250 fpm (6.35 m/s)  
**Air Volume Delivered:** Above 9250 cfm (4.37 m<sup>3</sup>/s)  
**Pressure Loss:** 0.24 in.wg. (60 Pa)

**Velocity @ 0.15 in.wg. Pressure Loss:** 980 fpm (4.98 m/s)

**\*Florida Building Code Approval (2014-FBC):** No. FL16955.1

**Design Load:** up to 187 psf - refer to FBC Installation Instructions for size and design load rating.

**Std. Design Load:** 30 psf

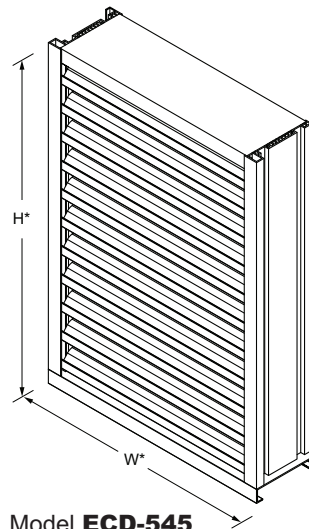

Model **ECD-545**  
(standard)

\*Louver dimensions furnished approximately 1/2" (13) undersize.

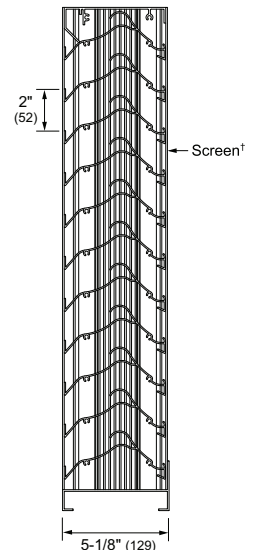

**Vertical Section**

†Screen adds approximately 3/16" (5) to louver depth.

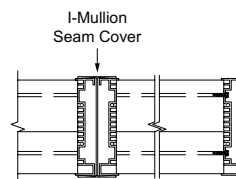

**Visible Vertical Mullion**  
(standard)

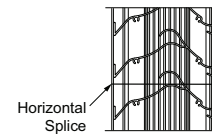

**Horizontal Mullion**  
(standard)

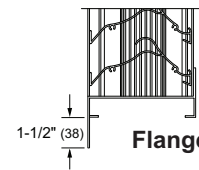

**Flange Frame**  
(optional)

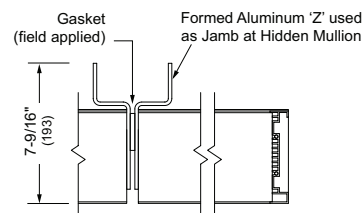

**Hidden Vertical Mullion**  
(optional)



### Certified Ratings:

All-Lite certifies that the model ECD-545 shown herein is licensed to bear the AMCA seal. The ratings shown are based on test and procedures performed in accordance with AMCA Publication 511 and comply with the requirements of the AMCA Certified Ratings Program. The AMCA Certified Ratings seal applies to air performance, water penetration and wind-driven rain ratings.

\*Optional - Requires Florida Building Code Construction

**Free Area (ft<sup>2</sup>)**

		Width (Inches)																			
		4.5	12	18	24	30	36	42	48	54	60	66	72	78	84	90	96	102	108	114	120
Height (Inches)	7	0.02	0.1	0.1	0.1	0.2	0.2	0.3	0.3	0.3	0.4	0.4	0.4	0.5	0.5	0.6	0.6	0.6	0.7	0.7	0.7
	12	0.1	0.3	0.5	0.7	0.8	1.0	1.2	1.4	1.6	1.8	1.9	2.1	2.3	2.5	2.7	2.8	3.0	3.2	3.4	3.6
	18	0.1	0.5	0.8	1.1	1.5	1.8	2.1	2.4	2.7	3.0	3.3	3.6	3.9	4.2	4.6	4.9	5.2	5.5	5.8	6.1
	24	0.2	0.7	1.2	1.6	2.1	2.5	2.9	3.4	3.8	4.3	4.7	5.1	5.6	6.0	6.5	6.9	7.3	7.8	8.2	8.7
	30	0.2	0.9	1.5	2.1	2.7	3.2	3.8	4.4	4.9	5.5	6.1	6.6	7.2	7.8	8.4	8.9	9.5	10.1	10.6	11.2
	36	0.3	1.2	1.9	2.6	3.3	4.0	4.7	5.4	6.1	6.8	7.5	8.2	8.9	9.6	10.3	10.9	11.6	12.3	13.0	13.7
	42	0.3	1.4	2.2	3.0	3.9	4.7	5.5	6.4	7.2	8.0	8.8	9.7	10.5	11.3	12.1	13.0	13.8	14.6	15.5	16.3
	48	0.4	1.6	2.6	3.5	4.5	5.4	6.4	7.4	8.3	9.3	10.2	11.2	12.1	13.1	14.0	15.0	16.0	16.9	17.9	18.8
	54	0.5	1.8	2.9	4.0	5.1	6.2	7.2	8.3	9.4	10.5	11.6	12.7	13.8	14.9	15.9	17.0	18.1	19.2	20.3	21.4
	60	0.5	2.0	3.2	4.5	5.7	6.9	8.1	9.3	10.5	11.8	13.0	14.2	15.4	16.6	17.8	19.1	20.3	21.5	22.7	23.9
	66	0.6	2.2	3.6	4.9	6.3	7.6	9.0	10.3	11.7	13.0	14.4	15.7	17.0	18.4	19.7	21.1	22.4	23.8	25.1	26.5
	72	0.6	2.5	3.9	5.4	6.9	8.4	9.8	11.3	12.8	14.3	15.7	17.2	18.7	20.2	21.6	23.1	24.6	26.1	27.5	29.0
	78	0.7	2.7	4.3	5.9	7.5	9.1	10.7	12.3	13.9	15.5	17.1	18.7	20.3	21.9	23.5	25.1	26.7	28.3	30.0	31.6
	84	0.7	2.9	4.6	6.4	8.1	9.8	11.6	13.3	15.0	16.8	18.5	20.2	22.0	23.7	25.4	27.2	28.9	30.6	32.4	34.1
90	0.8	3.1	5.0	6.8	8.7	10.6	12.4	14.3	16.1	18.0	19.9	21.7	23.6	25.5	27.3	29.2	31.1	32.9	34.8	36.6	
96	0.8	3.3	5.3	7.3	9.3	11.3	13.3	15.3	17.3	19.3	21.3	23.2	25.2	27.2	29.2	31.2	33.2	35.2	37.2	39.2	
102	0.9	3.5	5.7	7.8	9.9	12.0	14.1	16.3	18.4	20.5	22.6	24.8	26.9	29.0	31.1	33.2	35.4	37.5	39.6	41.7	
108	0.9	3.8	6.0	8.3	10.5	12.8	15.0	17.3	19.5	21.8	24.0	26.3	28.5	30.8	33.0	35.3	37.5	39.8	42.0	44.3	
114	1.0	4.0	6.3	8.7	11.1	13.5	15.9	18.3	20.6	23.0	25.4	27.8	30.2	32.5	34.9	37.3	39.7	42.1	44.4	46.8	
120	1.0	4.2	6.7	9.2	11.7	14.2	16.7	19.2	21.8	24.3	26.8	29.3	31.8	34.3	36.8	39.3	41.8	44.3	46.9	49.4	



**Certified Ratings:**  
All-Lite certifies that the model ECD-545 shown herein is licensed to bear the AMCA seal. The ratings shown are based on test and procedures performed in accordance with AMCA Publication 511 and comply with the requirements of the AMCA Certified Ratings Program. The AMCA Certified Ratings seal applies to air performance, water penetration and wind-driven rain ratings.

**Pressure Loss**

(Data corrected to standard air density)

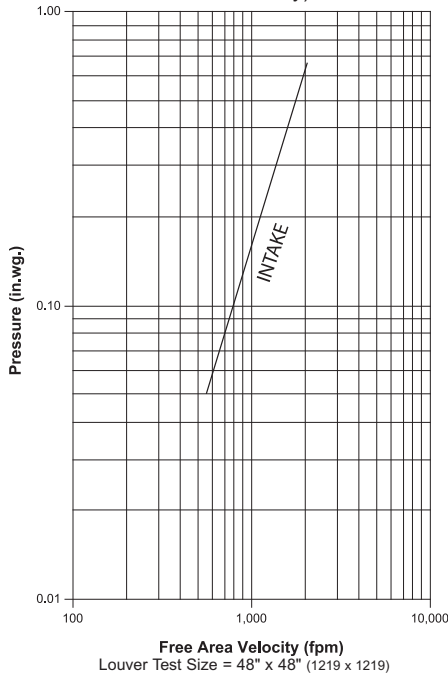

Free Area Velocity (fpm)  
Louver Test Size = 48" x 48" (1219 x 1219)

Pressure loss tested in accordance with Figure 5.5 of AMCA Standard 500-L.

**Water Penetration**

AMCA defines the beginning point of water penetration as the free area velocity at the intersection of a simple linear regression of test data and the line of 0.01 ounces of water per square foot of free area and is measured through a 48" x 48" louver during a 15 minute period. The AMCA water penetration test provides a method for comparing louver models and designs as to their efficiency in resisting the penetration of rainfall under specific lab conditions. All-Lite recommends that intake louvers are selected with a reasonable margin of safety below the beginning point of water penetration in order to avoid unwanted penetration during severe storm conditions.

**Wind Driven Rain Performance — AMCA 500-L Wind Driven Rain Test**

Test louver Core Area, is 39<sup>3</sup>/<sub>8</sub>" x 39<sup>3</sup>/<sub>8</sub>".

Wind Velocity	Rainfall	Airflow	Core Velocity	Effectiveness Ratio	Wind Class	Discharge Class
29 mph	3 in/hr	9276 cfm	862 fpm	99.4%	A	2
50 mph	8 in/hr	10,502 cfm	975 fpm	95.3%	B	2

Wind Driven Rain <sub>2</sub>		Discharge Loss <sub>3</sub>
Class	Effectiveness	Coefficient
A	1.000 to 0.99	0.4 to 1.000
B	0.989 to 0.95	0.3 to 0.399
C	0.949 to 0.80	0.2 to 0.299
D	0.799 to 0.00	0.0 to 0.199

**NOTES**

1. Core Area is the open area of the louver face (face area less louver frame). 2. Wind Driven Rain Penetration Classes. 3. Discharge Loss Coefficient is calculated by dividing the louvers' actual airflow rate by the theoretical airflow rate for an unobstructed opening. The higher the coefficient the lower the resistance to air flow.

Information is correct at time of printing. However, we reserve the right to make changes without notice.

**NOTE:** Dimensions in parentheses ( ) are millimeters.